

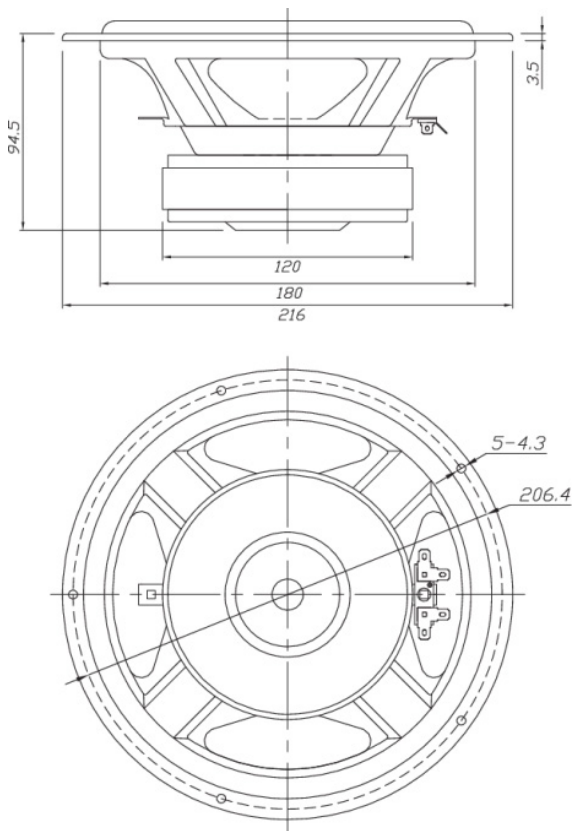

DA215-8 8" Aluminum Cone Woofer

DA215-8



PARAMETERS

Impedance	8 ohms
Re	6.8 ohms
Le	1.44 mH
Fs	34.9 Hz
Qms	1.95
Qes	0.45
Qts	0.37
Mms	30.3g
Cms	0.68 mm/N
Sd	211.2 cm ²
Vd	112.0 cm ³
BL	10.00 Tm
Vas	42.7 liters
Xmax	5.3 mm
VC Diameter	36 mm
SPL	88.7 dB @ 1W/1m
RMS Power Handling	60 watts
Usable Frequency Range (Hz)	35 - 8,000 Hz

FEATURES

- Great looking and sounding woofer
- One-piece aluminum cone
- Cosmetic stamped steel frame
- Flat frequency response in passband region
- Impressive output capabilities when used in MTM designs

IMPEDANCE/PHASE

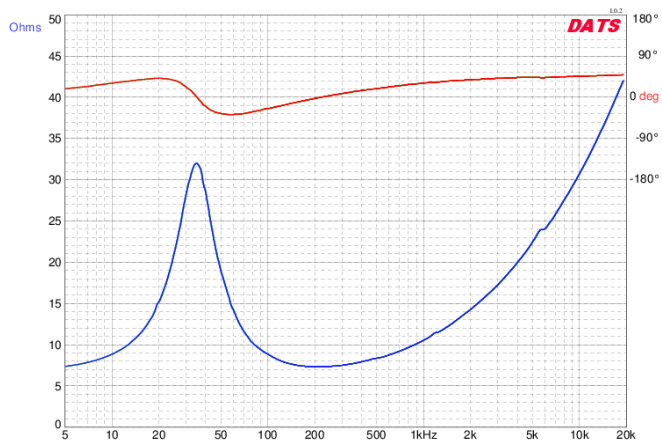

FREQUENCY RESPONSE

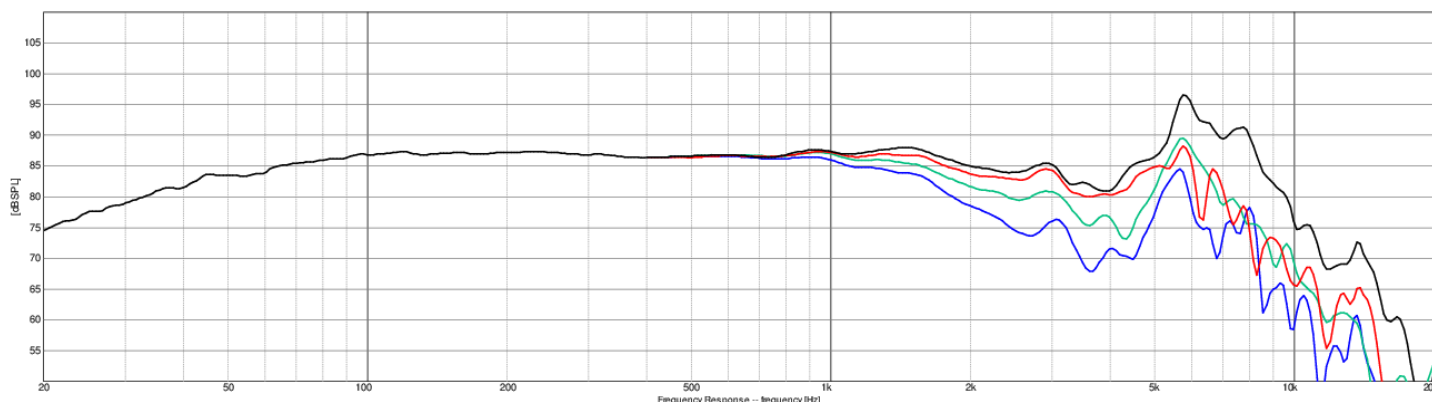

Note: 1/12th octave smoothing - nearfield response included in graph below 450 Hz.

Black = 0°
Red = 15°
Green = 30°
Blue = 45°